



Automation for a Changing World

Delta Sensorless Vector Control Compact Drive VFD-EL Series



www.deltaww.com

 **DELTA**
Smarter. Greener. Together.

Features

▶ **Standard MODBUS Protocol**

Standard MODBUS protocol via RS-485

▶ **Built-in EMC Filter (230V single-phase and 460V 3-phase)**

The built-in EMC filter reduces electromagnetic interference and complies with the EN61800-3 standard

▶ **Compact Design**

Space saving and easy DIN rail mounting with optional DIN rail adapter (Built-in for Frame B)

▶ **Optional Fieldbus Modules**

Provide connection to a variety of networks, including PROFIBUS, DeviceNet and CANopen

▶ **RFI Switch for IT Mains**

Removable "Y" capacitor to use with IT mains supplies



▶ **DC Bus Sharing**

Multiple VFD-EL can be connected in parallel to share the regenerative braking energy. This prevents over-voltage and stabilizes DC bus voltage.

*This function is not supported by the 115V model.

▶ **Complete Protection Functions**

High precision current detection, full overload protection (oL, oL1 and oL2), overvoltage/overcurrent stall prevention, short-circuit protection, reset after fault, speed search function and motor overheat protection by PTC

▶ **Power Range**

Single-phase 115V series: 0.2~0.75kW (0.25~1 hp)

Single-phase 230V series: 0.2~2.2kW (0.25~3 hp)

3-phase 230V series: 0.2~3.7kW (0.25~5 hp)

3-phase 460V series: 0.4~3.7kW (0.50~5 hp)

▶ **Side-by-side Installation (40°C)**

High-efficiency cooling and flexible spacing



▶ **Easy Maintenance**

Removable cooling fan for easy maintenance



Applications

Conveyor Belts

1. Multi-step speed application: provides multi-step speed settings to meet the needs of a conveyor belt
2. Side-by-side installation to save space
3. DC bus sharing: connects multiple drives in parallel to share the regenerative energy and prevent overvoltage



Winders

Auto acceleration/deceleration function provides rapid start/stop of operation and increases productivity and efficiency

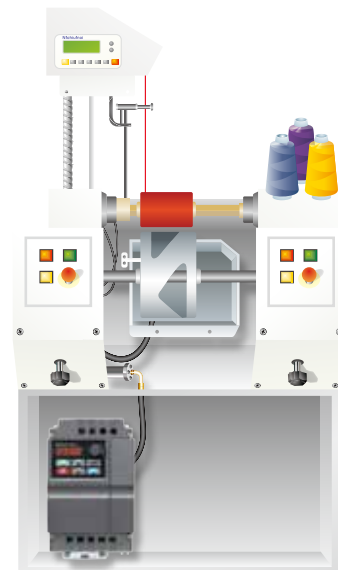

Constant Pressure Control of Water Pumps

1. Built-in smart PID controller saves the cost of a specified external PID meter
2. Built-in auto detection of water suspension and auto power-on saves the cost of external PLC controller and relay
3. A wide range of input voltages are available, including single-phase 110V/230V and 3-phase 230V/460V, for various pump applications and different countries

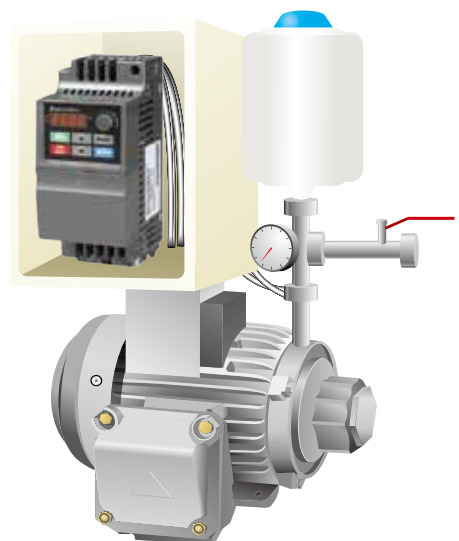

Standard Wiring Diagram

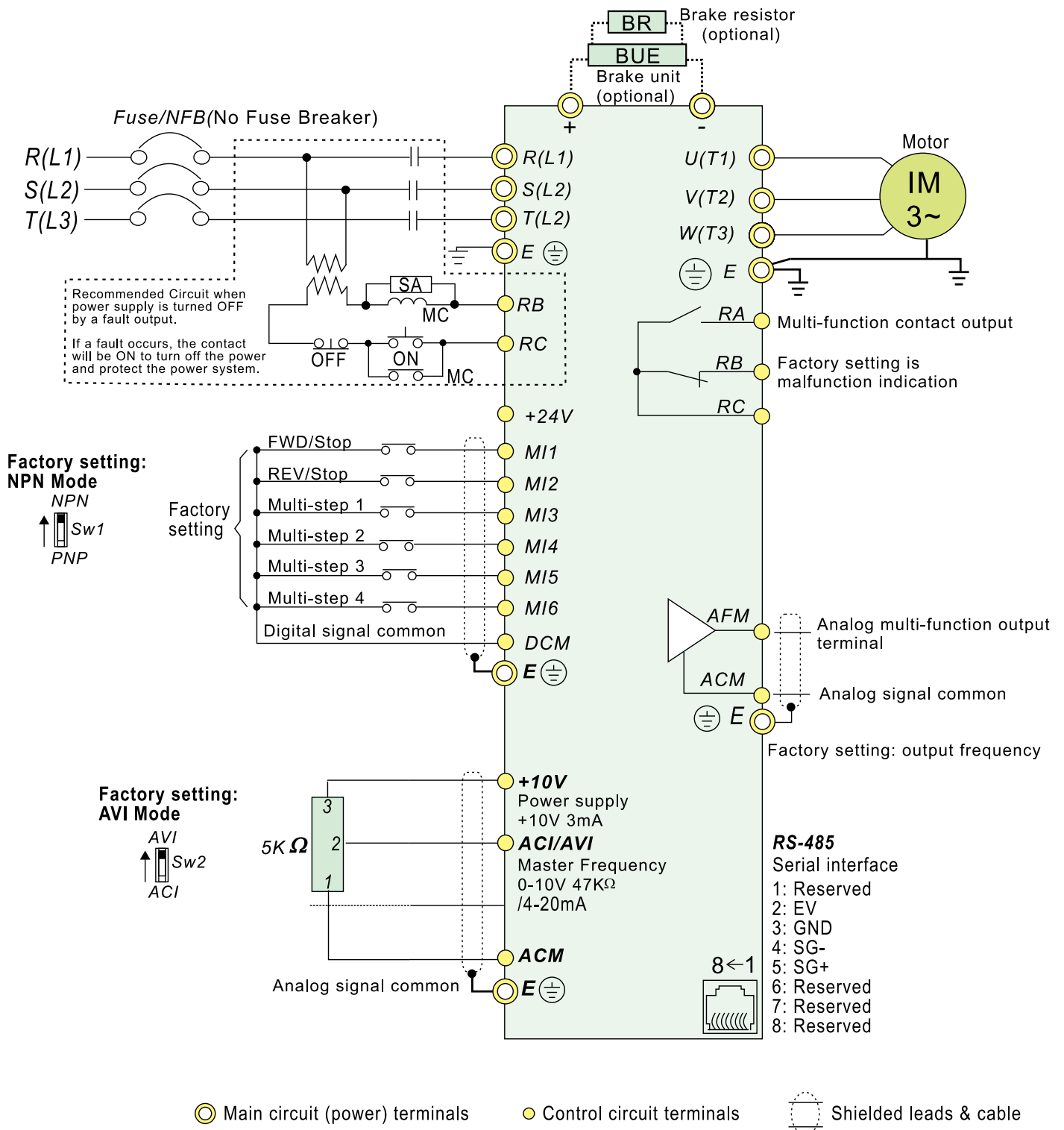

NOTE

It is recommended to install circuit breaker at the control terminal to protect the circuit from operation abnormality or sudden power outage.

The protection circuit uses the multi-function output terminal of the AC motor drive for connection. When an abnormal condition (closed contact) occurs, the external power supply is disconnected to protect the power system of the AC motor drive.

External Parts

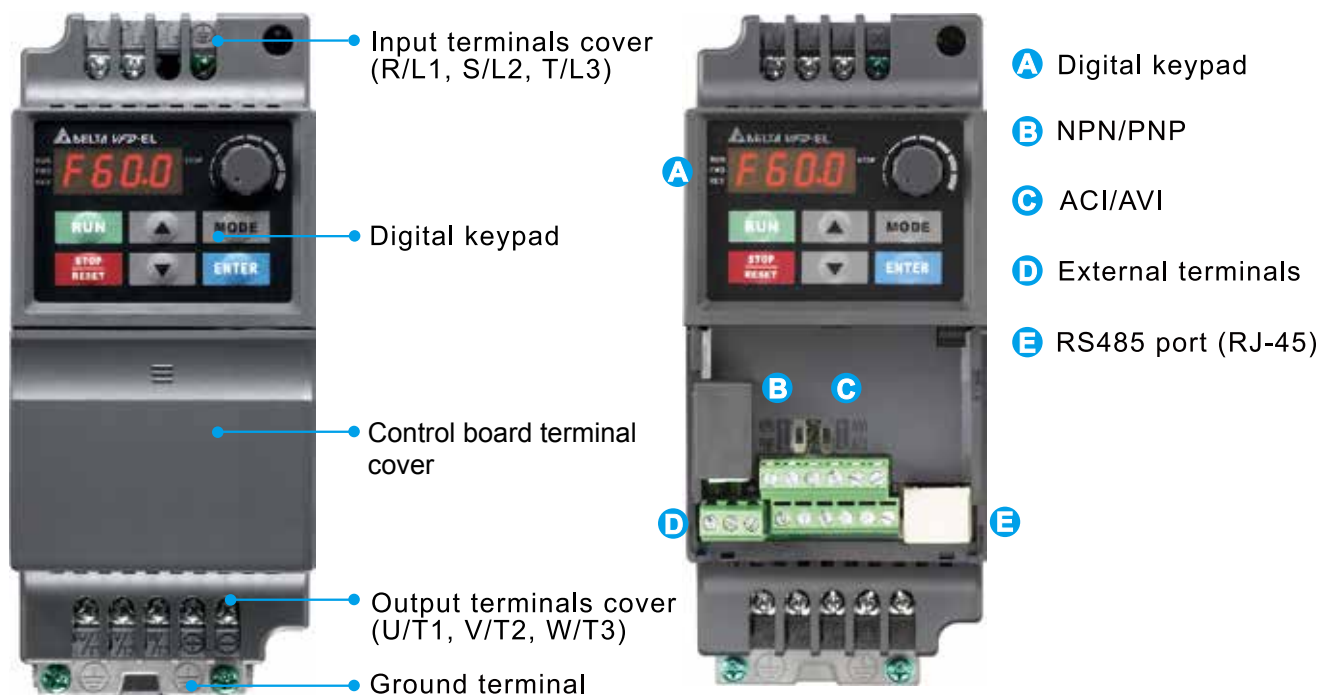

Control Terminals

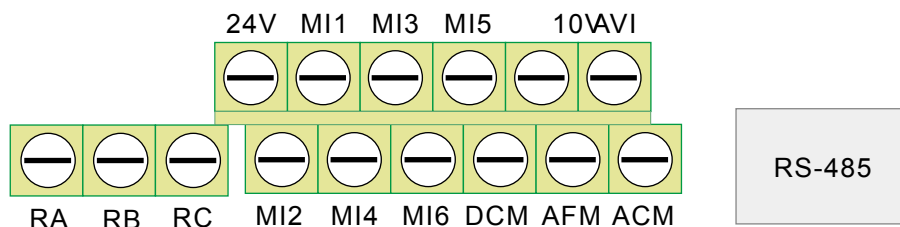

Model Explanation

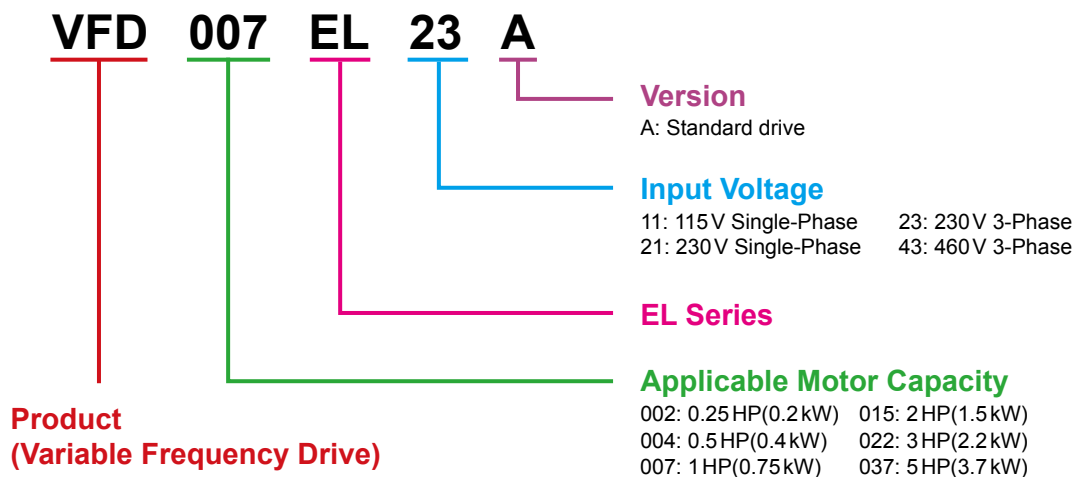

Application Fields

Conveyor and Transportation Machinery

- Conveyor belt
- Automatic door
- Roller door
- Small elevator
- Escalator
- X,Y-axis traveling crane

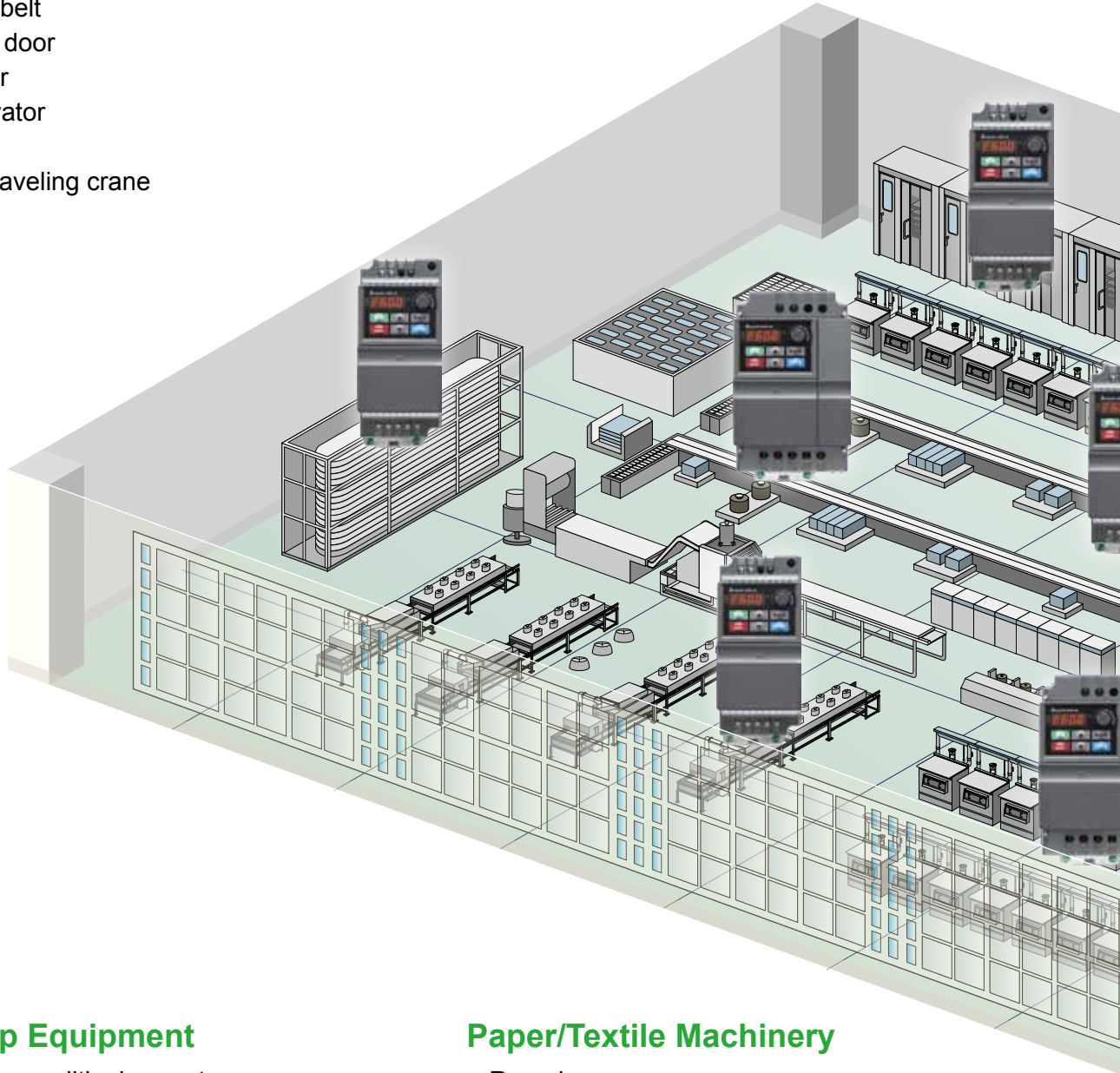

Fan/Pump Equipment

- Building air conditioning system
- Wastewater processing system
- Constant pressure water treatment system
- Water treatment pump
- Agricultural pump
- Temperature control of mid and larger oven
- Air compressor
- Heat exchange fan
- Building water dispenser system
- Dryer's windmill

Paper/Textile Machinery

- Round weaver
- Cross weaver
- Ribbon weaver
- Printing press
- Industrial sewing machine
- Knitting machine

Food Processing

- Dumpling making machine
- Food mixer
- Noodle making machine

Wood Working Machinery

- 4 side planer
- Wood carving machine
- Woodworking machine
- Simple cutting machine for wood working
- Spraying machine

Machine Tool/Metal Processing Machinery

- Grinding machine
- Drilling machine
- Small lathe
- Milling machine
- Injection molding (clamp)

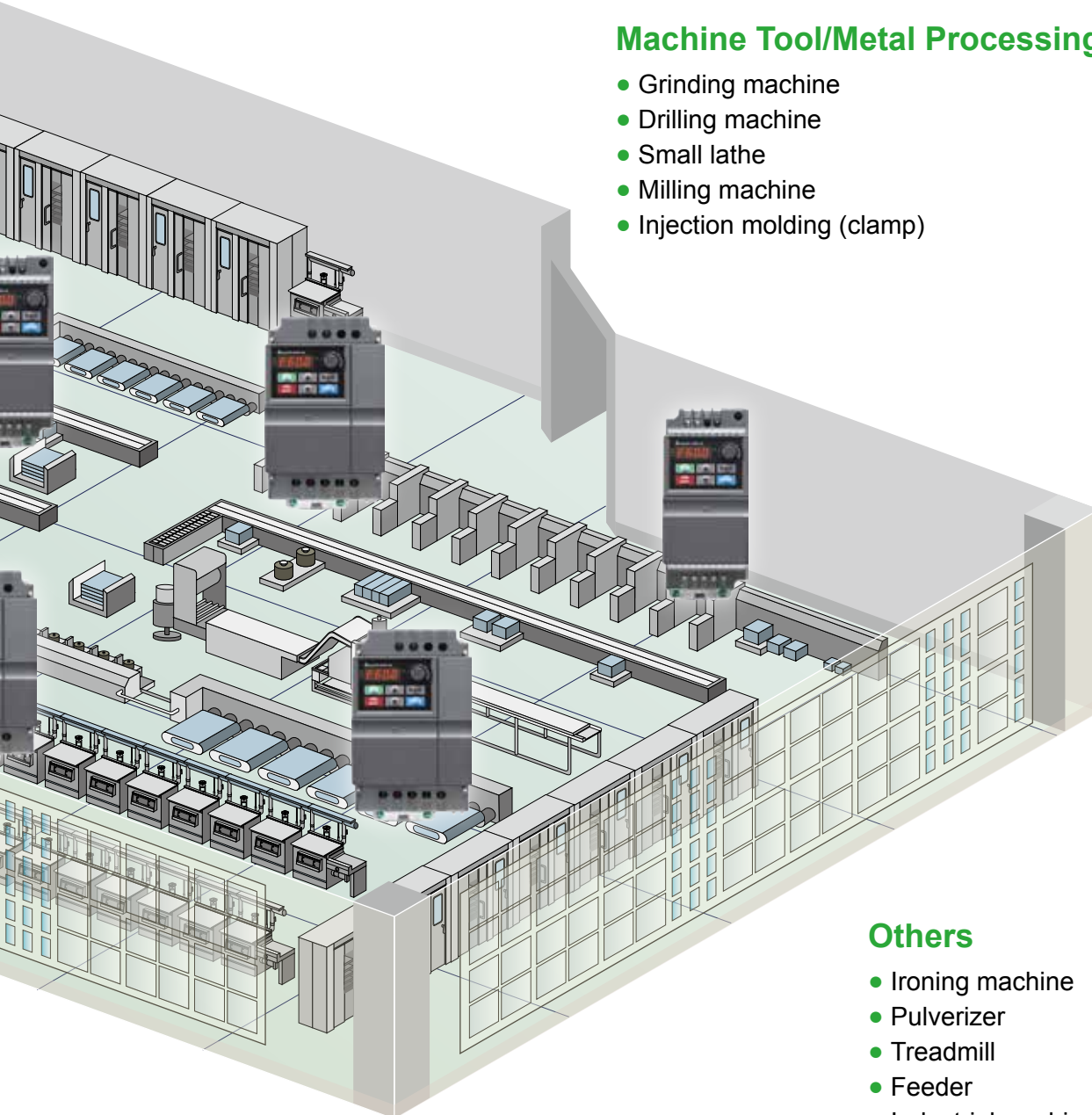



Others

- Ironing machine
- Pulverizer
- Treadmill
- Feeder
- Industrial washing machine
- Car washing machine
- Packing machine
- Centrifuge
- Liquid mixing machine

Specifications

115V	Voltage Class		115V							
	Model Number VFD-___ EL		002	004	007					
	Max. Applicable Motor Output (kW)		0.2	0.4	0.75					
	Max. Applicable Motor Output (Hp)		0.25	0.5	1.0					
	Output Rating	Rated Output Capacity (kVA)		0.6	1.0	1.6				
		Rated Output Current (A)		1.6	2.5	4.2				
		Maximum Output Voltage (V)		3-phase proportional to twice the input voltage						
		Output Frequency (Hz)		0.1~599Hz						
		Carrier Frequency (kHz)		2-12						
	Input Rating	Rated Input Current (A)		Single-phase						
				6.4	9	18				
		Rated Voltage/Frequency		Single-phase 100-120V, 50/60Hz						
		Voltage Tolerance		±10% (90-132V)						
		Frequency Tolerance		±5% (47-63Hz)						
	Cooling Method		Natural cooling		Fan cooling					
Weight (kg)		1.1	1.1	1.4						
230V	Voltage Class		230V							
	Model Number VFD-___ EL		002	004	007	015	022	037		
	Max. Applicable Motor Output (kW)		0.2	0.4	0.75	1.5	2.2	3.7		
	Max. Applicable Motor Output (Hp)		0.25	0.5	1.0	2.0	3.0	5.0		
	Output Rating	Rated Output Capacity (kVA)		0.6	1.0	1.6	2.9	4.2	6.5	
		Rated Output Current (A)		1.6	2.5	4.2	7.5	11.0	17.0	
		Maximum Output Voltage (V)		3-phase proportional to input voltage						
		Output Frequency (Hz)		0.1~599Hz						
		Carrier Frequency (kHz)		2-12						
	Input Rating	XXXE L21A	Rated Input Current (A)		4.9	6.5	9.5	15.7	24	--
			Rated Voltage/Frequency		Single-phase, 200-240V, 50/60Hz					
		XXXE L23A	Rated Input Current (A)		1.9	2.7	4.9	9	15	20.6
			Rated Voltage/Frequency		Single-phase/3-phase, 200-240V, 50/60Hz					
		Voltage Tolerance		±10% (180-264V)						
	Frequency Tolerance		±5% (47-63Hz)							
Cooling Method		Natural cooling			Fan cooling					
Weight (kg)		1.2	1.2	1.2	1.7	1.7	1.7			
460V	Voltage Class		460V							
	Model Number VFD-___ EL		004	007	015	022	037			
	Max. Applicable Motor Output (kW)		0.4	0.75	1.5	2.2	3.7			
	Max. Applicable Motor Output (hp)		0.5	1.0	2.0	3.0	5.0			
	Output Rating	Rated Output Capacity (kVA)		1.2	2.0	3.3	4.4	6.8		
		Rated Output Current (A)		1.5	2.5	4.2	5.5	8.2		
		Maximum Output Voltage (V)		3-phase proportional to input voltage						
		Output Frequency (Hz)		0.1~599 Hz						
		Carrier Frequency (kHz)		2-12						
	Input Rating	Rated Input Current (A)		3-phase						
				1.8	3.2	4.3	7.1	9.0		
		Rated Voltage/Frequency		3-phase, 380-480V, 50/60Hz						
		Voltage Tolerance		±10% (342~528V)						
		Frequency Tolerance		±5% (47~63Hz)						
	Cooling Method		Natural cooling			Fan cooling				
Weight (kg)		1.2	1.2	1.2	1.7	1.7				

Control Characteristics	Control System		SPWM (Sinusoidal Pulse Width Modulation) control (V/F control)
	Frequency Setting Resolution		0.01 Hz
	Output Frequency Resolution		0.01 Hz
	Torque Characteristics		Including the auto-torque/auto-slip compensation; starting torque can be 150% at 5.0Hz
	Overload Endurance		150% of rated current for 1 minute
	Skip Frequency		Three zones, setting range 0.1 - 599Hz
	Accel/Decel Time		0.1 to 600 seconds (2 Independent settings for Accel/Decel time)
	Stall Prevention Level		Setting 20 to 250% of rated current
	DC Braking		Operation frequency 0.1 - 599.0 Hz, output 0-100% rated current Start time 0-60 seconds, stop time 0-60 seconds
	Regenerated Braking Torque		Approx. 20% (up to 125% possible with optional brake resistor or externally mounted brake unit, 1-15hp (0.75-11 kW) models have brake chopper built-in)
	V/F Pattern		Adjustable V/F pattern
	Operating Characteristics	Frequency Setting	Keypad
External Signal			Potentiometer 5k/0.5W, 0 to +10V _{DC} , 4 to 20 mA, RS-485 interface; Multi-function Inputs 3 to 6 (15 steps, Jog, up/down)
Operation Setting Signal		Keypad	Set by RUN and STOP
		External Signal	2 wires/3 wires (MI1, MI2, MI3), JOG operation, RS-485 serial interface (MODBUS)
Multi-function Input Signal		Multi-step selection 0 to 15, Jog, accel/dec el inhibit, 2 accel/dec el switches, counter, external Base Block, ACI/AVI selections, driver reset, UP/DOWN key settings, NPN/PNP input selection	
Multi-function Output Indication		AC drive operating, frequency attained, counter attained, zero speed, Base Block, fault indication, overheat alarm, emergency stop and status selections of input terminals	
Analog Output Signal		Output frequency/current	
Alarm Output Contact		Contact will be ON when drive malfunctions (1 Form C/change-over contact or 1 open collector output)	
Operation Functions		AVR, accel/dec el S-Curve, overvoltage/overcurrent stall prevention, 5 fault records, reverse inhibition, momentary power loss restart, DC braking, auto torque/slip compensation, adjustable carrier frequency, output frequency limits, parameter lock/reset, PID control, external counter, MODBUS communication, abnormal reset, abnormal re-start, power-saving, fan control, sleep/wake frequency, 1st/2nd frequency source selections, 1st/2nd frequency source combination, NPN/PNP selection	
Protection Functions		Over voltage, over current, under voltage, external fault, overload, ground fault, overheating, electronic thermal, IGBT short circuit, PTC	
Display Keypad		6-key, 7-segment LED with 4-digit, 4 status LEDs, master frequency, output frequency, output current, custom units, parameter values for setup and lock, faults, RUN, STOP, RESET, FWD/REV	
Built-in EMC Filter		For 230V 1-phase and 460V 3-phase models	
Environmental Conditions	Enclosure Rating		IP20
	Pollution Degree		2
	Installation Location		Altitude 1,000 m or lower, keep from corrosive gasses, liquid and dust
	Ambient Temperature		-10 °C to + 50 °C (40 °C for side-by-side mounting) Non-Condensing and not frozen
	Storage/ Transportation Temperature		-20 °C to 60 °C
	Ambient Humidity		Below 90% RH (non-condensing)
	Vibration		9.80665 m/s ² (1G) less than 20 Hz, 5.88 m/s (0.6G) at 20 to 50 Hz
Certifications		  	

Dimensions

Frame A

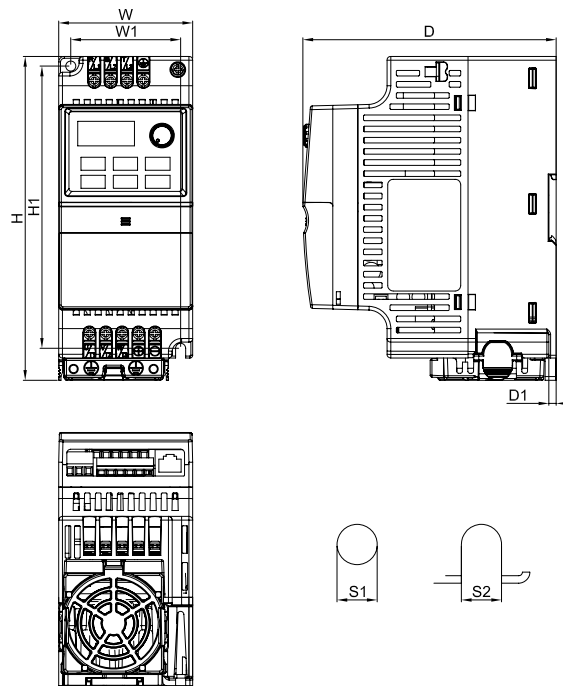

MODEL

- VFD002EL11A
- VFD002EL21A
- VFD002EL23A
- VFD004EL11A
- VFD004EL21A
- VFD004EL23A
- VDF004EL43A
- VFD007EL21A
- VDF007EL23A
- VDF007EL43A
- VDF015EL23A
- VDF015EL43A

Unit: mm[inch]

Frame		W	H	D	W1	H1	D1	S1	S2
A	mm	72.0	174.0	136.0	59.0	151.6	4.0	5.4	5.4
	inch	2.83	6.86	5.36	2.32	5.97	0.16	0.21	0.21

Frame B

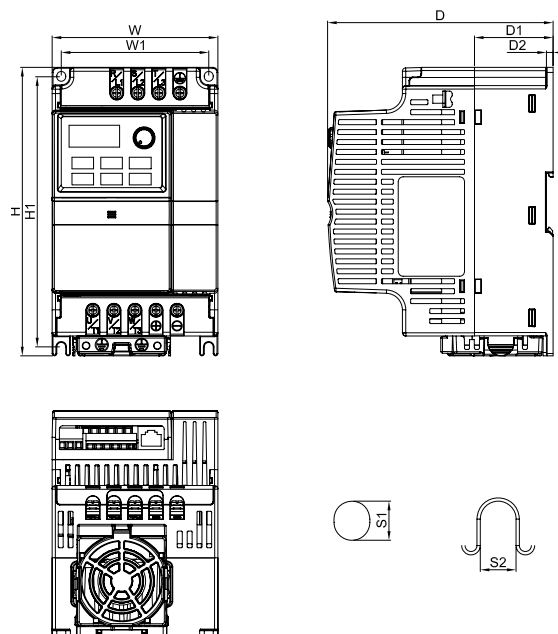

MODEL

- VFD007EL11A
- VFD015EL21A
- VFD022EL21A
- VDF022EL23A
- VFD022EL43A
- VDF037EL23A
- VDF037EL43A

Unit: mm[inch]

Frame		W	H	D	W1	H1	D1	D2	S1	S2
B	mm	100.0	174.0	136.0	89.0	162.9	47.4	4.0	5.9	5.4
	inch	3.94	6.85	5.36	3.50	6.42	1.87	0.16	0.23	0.21

Accessories

Fieldbus Modules



▪ **DeviceNet**
CME-DN01



▪ **PROFIBUS**
CME-PD01



▪ **CANopen**
CME-COP01

Others



▪ **Brake unit**
BUE-20015 BUE-40015
BUE-20037 BUE-40037



▪ **Communication keypad**
VFD-PU06



▪ **DIN Rail (Width 35mm)**
MKEL-DRA MKEL-DRB



▪ **Brake resistor**





▪ **Zero phase reactor**
RF220X00A



▪ **Grounding plate**
MKE-EP

Ordering Information

Frame Size		Power Range	Models
Frame A		115V: 0.2kW ~ 0.4kW 230V: 0.2kW ~ 1.5kW 460V: 0.4kW ~ 1.5kW	VFD002EL 11A / 21A / 23A VFD004EL 11A / 21A / 23A / 43A VFD007EL 21A / 23A / 43A VFD015EL 23A / 43A
Frame B		115V: 0.75kW 230V: 1.5kW ~ 3.7kW 460V: 2.2kW ~ 3.7kW	VFD007EL11A VFD015EL 21A VFD022EL 21A / 23A / 43A VFD037EL 23A / 43A



Smarter. Greener. Together.

Industrial Automation Headquarters

Delta Electronics, Inc.

Taoyuan Technology Center
18 Xinglong Road, Taoyuan District,
Taoyuan City 33068, Taiwan (R.O.C.)
TEL: 886-3-362-6301 / FAX: 886-3-371-6301

Asia

Delta Electronics (Jiangsu) Ltd.

Wujiang Plant 3
1688 Jiangxing East Road,
Wujiang Economic Development Zone
Wujiang City, Jiang Su Province, P.R.C. 215200
TEL: 86-512-6340-3008 / FAX: 86-769-6340-7290

Delta Greentech (China) Co., Ltd.

238 Min-Xia Road, Pudong District,
ShangHai, P.R.C. 201209
TEL: 86-21-58635678 / FAX: 86-21-58630003

Delta Electronics (Japan), Inc.

Tokyo Office
2-1-14 Minato-ku Shibadaimon,
Tokyo 105-0012, Japan
TEL: 81-3-5733-1111 / FAX: 81-3-5733-1211

Delta Electronics (Korea), Inc.

1511, Byucksan Digital Valley 6-cha, Gasan-dong,
Geumcheon-gu, Seoul, Korea, 153-704
TEL: 82-2-515-5303 / FAX: 82-2-515-5302

Delta Electronics Int'l (S) Pte Ltd.

4 Kaki Bukit Ave 1, #05-05, Singapore 417939
TEL: 65-6747-5155 / FAX: 65-6744-9228

Delta Electronics (India) Pvt. Ltd.

Plot No 43 Sector 35, HSIIDC
Gurgaon, PIN 122001, Haryana, India
TEL : 91-124-4874900 / FAX : 91-124-4874945

Americas

Delta Products Corporation (USA)

Raleigh Office
P.O. Box 12173, 5101 Davis Drive,
Research Triangle Park, NC 27709, U.S.A.
TEL: 1-919-767-3800 / FAX: 1-919-767-8080

Delta Greentech (Brasil) S.A.

Sao Paulo Office
Rua Itapeva, 26 - 3° andar Edificio Itapeva One-Bela Vista
01332-000-São Paulo-SP-Brazil
TEL: 55 11 3568-3855 / FAX: 55 11 3568-3865

Europe

Delta Electronics (Netherlands) B.V.

Eindhoven Office
De Witbogt 20, 5652 AG Eindhoven, The Netherlands
TEL: +31 (0)40-8003800 / FAX: +31 (0)40-8003898

*We reserve the right to change the information in this catalogue without prior notice.